

TOP VIEW

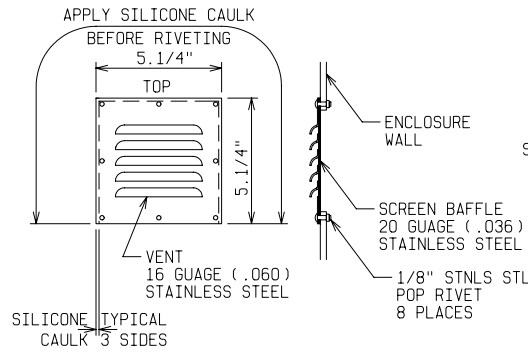

DETAIL A

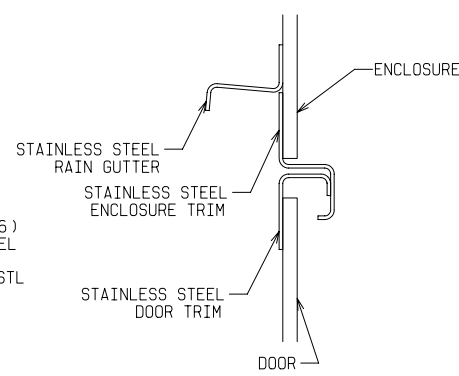

SECTION Z-Z

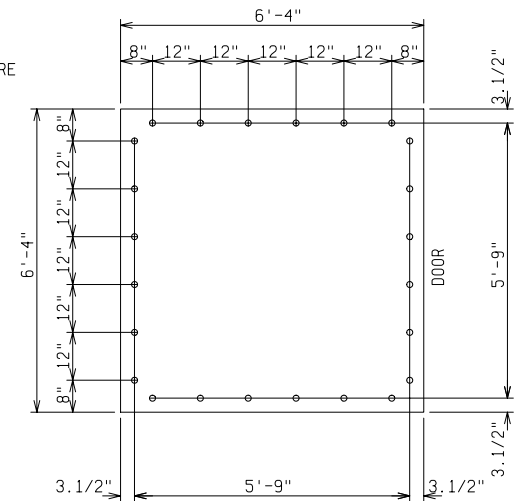

PAD & ANCHOR BOLT DETAIL

ANCHOR BOLTS TO BE 5/8" DIA. AND TO EXTEND 1-1/2" MINIMUM ABOVE PAD
PROVIDE UTILITY ENTRY AS REQUIRED

ORDERING INFORMATION:

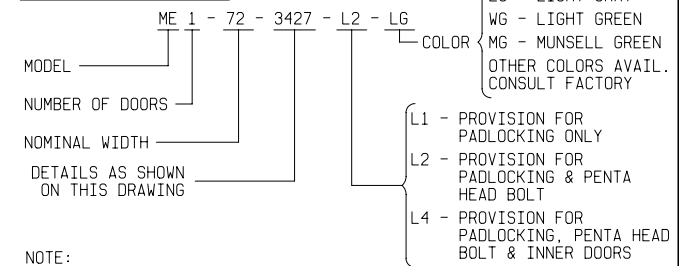

NOTE:

- MATERIAL:
 - FIBERGLASS LAMINATE 1/4" NOMINAL THICKNESS
 - EXTERIOR UV STABILIZED GELCOAT - 14 MIL NOMINAL THICKNESS
 - FIRE RETARDANT - DOES NOT SUPPORT COMBUSTION
 - STAINLESS STEEL HARDWARE
- STANDARDS:
 - CERTIFIED TEST DATA OF ASTM STRUCTURAL STANDARDS AVAILABLE UPON REQUEST

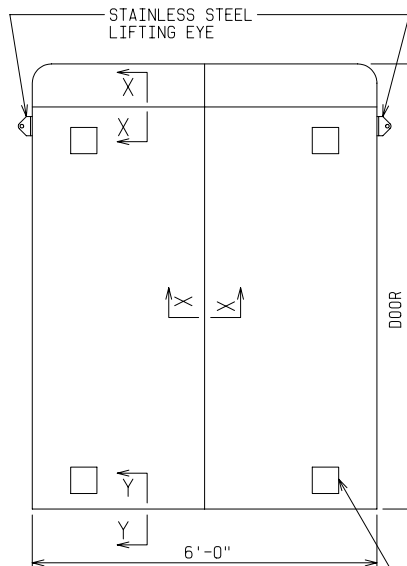

FRONT VIEW

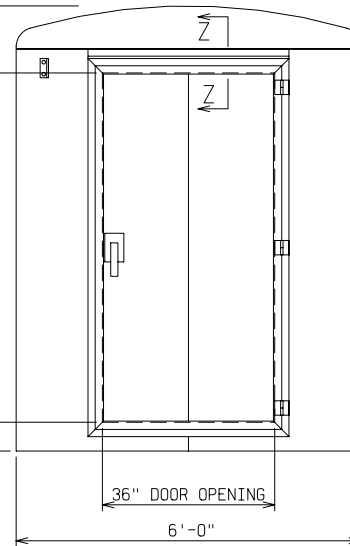

END VIEW

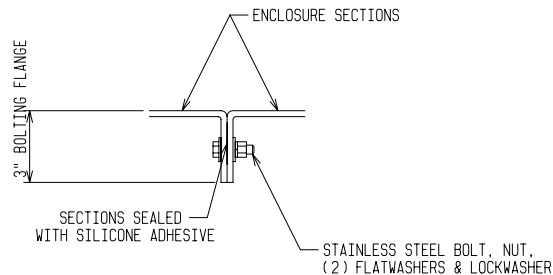

SECTION X-X

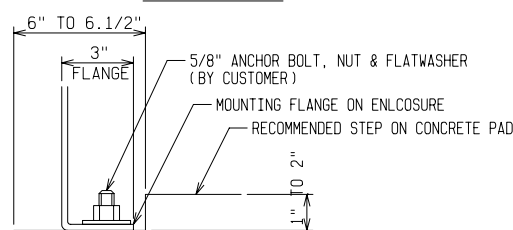

SECTION Y-Y

FIBERGLASS WALK-IN ENCLOSURE

6 FT WIDE x 7 FT 9 IN HIGH x 6 FT LONG

ONE ENTRY DOOR



POWER DESIGN INC.

ODELL, OREGON

DRAWN: BB	PAGE	DATE 4-4-03	DRAWING NO. 3427
--------------	------	----------------	---------------------

FILE REF: