

DETAIL A

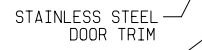

SECTION Z-Z

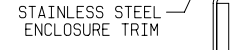
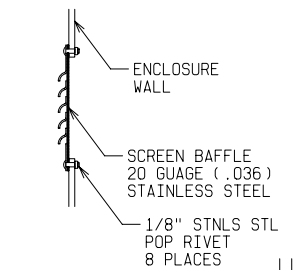
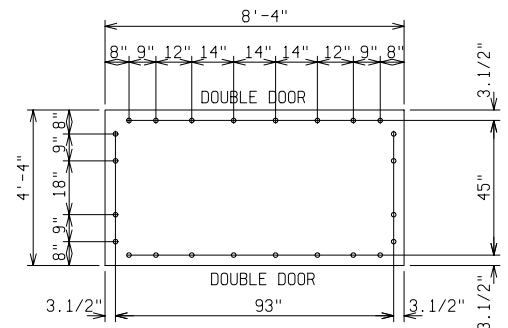
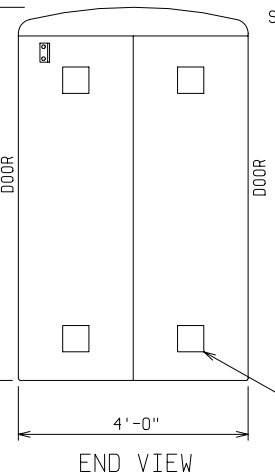
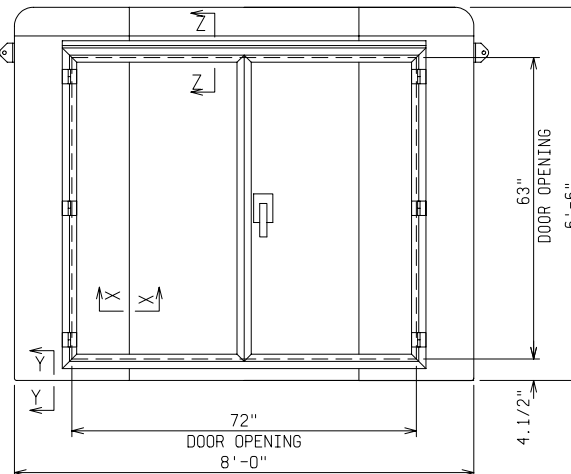

ANCHOR BOLTS TO BE 5/8" DIA. & TO EXTEND 1-1/2" MINIMUM ABOVE PAD. PROVIDE CABLE ENTRY AS REQ'D.

ORDERING INFORMATION:

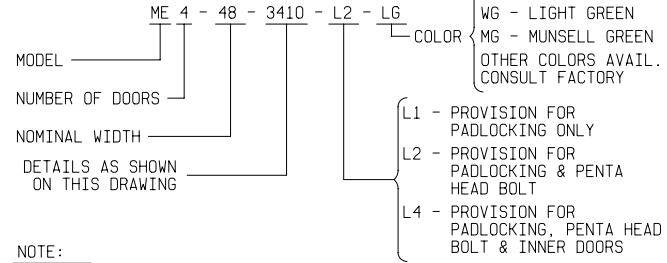

NOTE:

- MATERIAL:
 - FIBERGLASS LAMINATE 1/4" NOMINAL THICKNESS
 - EXTERIOR UV STABILIZED GELCOAT - 14 MIL NOMINAL THICKNESS
 - FIRE RETARDANT - DOES NOT SUPPORT COMBUSTION
 - STAINLESS STEEL HARDWARE
- STANDARDS:
 - CERTIFIED TEST DATA OF ASTM STRUCTURAL STANDARDS AVAILABLE UPON REQUEST

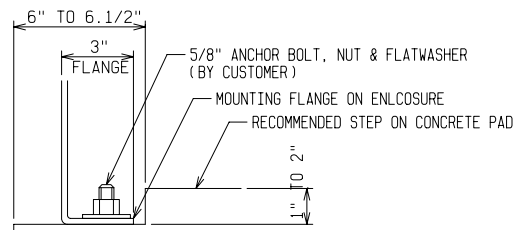
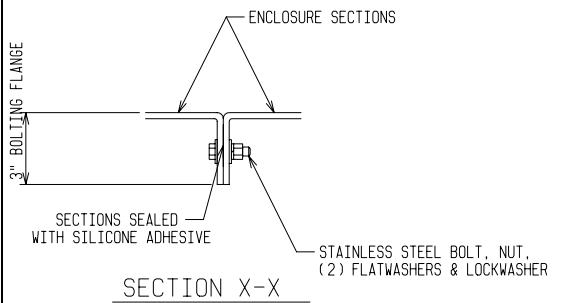

FIBERGLASS ENCLOSURE

4 FT WIDE x 6 FT 6 IN HIGH x 8 FT LONG

TWO DOUBLE ACCESS DOORS

POWER DESIGN INC.

ODELL, OREGON

| | | | |
|-----------|------|-------------|------------------|
| DRAWN: BB | PAGE | DATE 3-4-03 | DRAWING NO. 3410 |
|-----------|------|-------------|------------------|

FILE REF: